

www.davidhailant.com

David Hailant

Sheet: /

File: uc_divider.sch

Title: UC Clock Divider

Size: A4	Date: 2021-12-07	Rev: 1.0
KiCad E.D.A. kicad 6.0.1-79c1e3a40b-116-ubuntu20.04.1		Id: 1/5

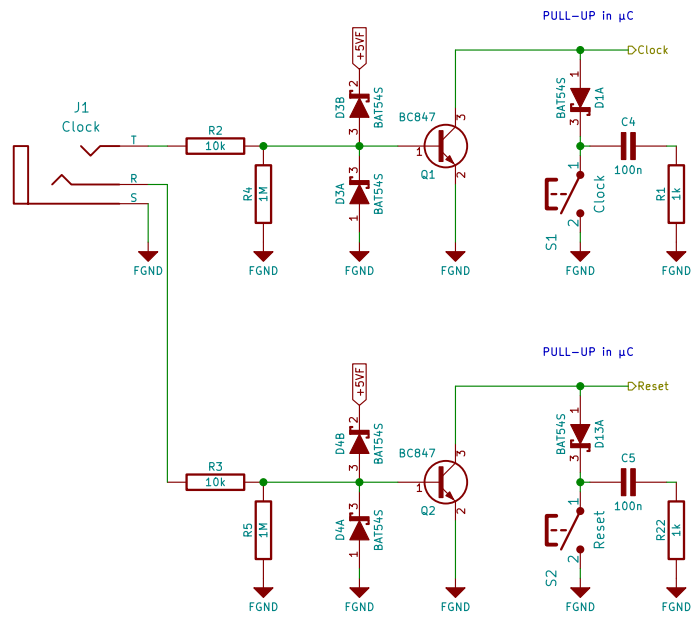

www.davidhailant.com

David Hailant

Sheet: /Inputs/

File: digital_inputs.sch

Title: UC Clock Divider

Size: A4

Date: 2021-12-07

Rev: 1.0

KiCad E.D.A. kicad 6.0.1-79c1e3a40b-116-ubuntu20.04.1

Id: 2/5

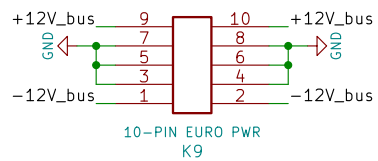

Schottky Diode 1A
 Ir 1mA max

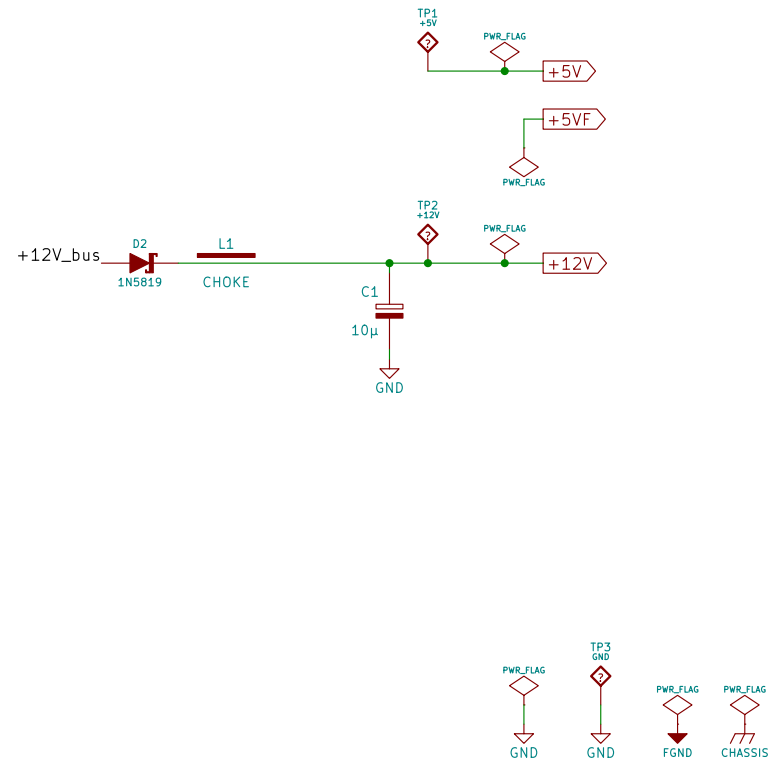

www.davidhailant.com

David Hailant

Sheet: /Power Supply/

File: power.sch

Title: UC Clock Divider

Size: A4

Date: 2021-12-07

Rev: 1.0

KiCad E.D.A. kicad 6.0.1-79c1e3a40b-116-ubuntu20.04.1

Id: 3/5

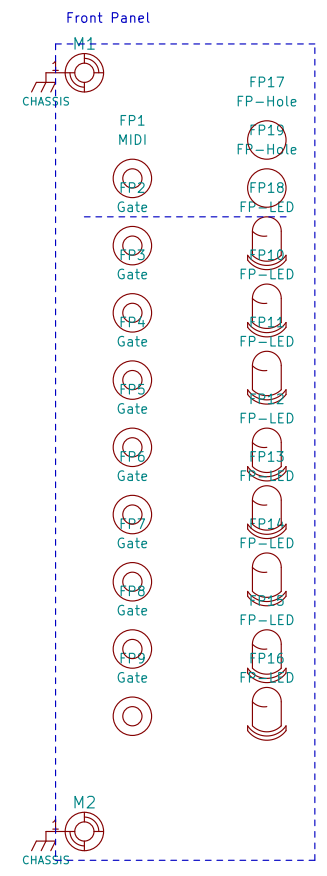
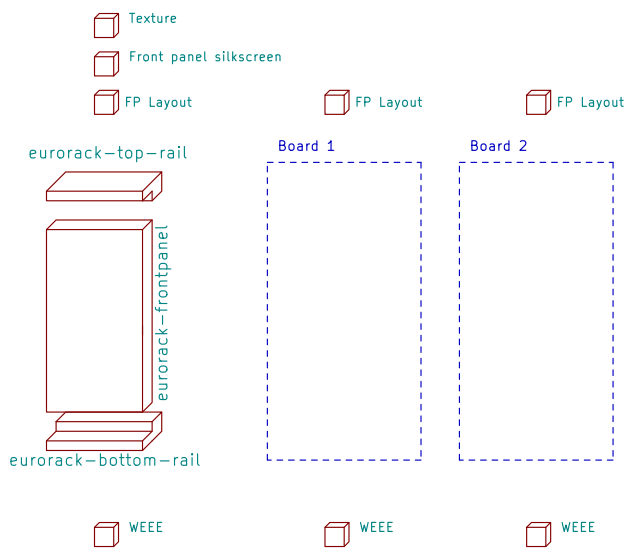

www.davidhailant.com	
David Hailant	
Sheet: /Front Panel/ File: frontpanel.sch	
Title: UC Clock Divider	
Size: A4	Date: 2021-12-07
KiCad E.D.A. kicad 6.0.1-79c1e3a40b-116-ubuntu20.04.1	Rev: 1.0 Id: 4/5

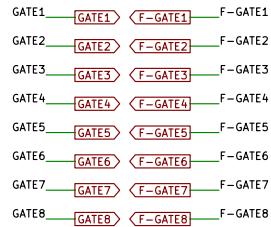
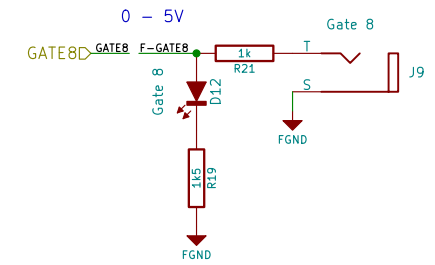
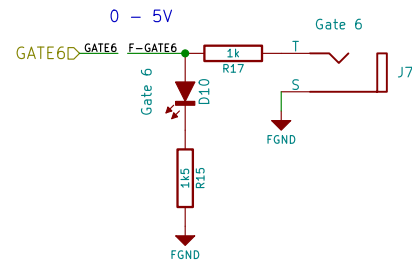
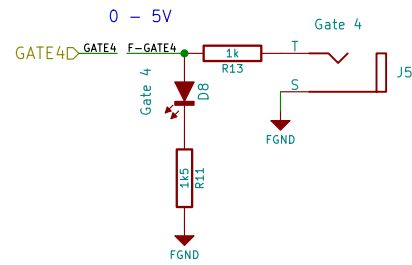
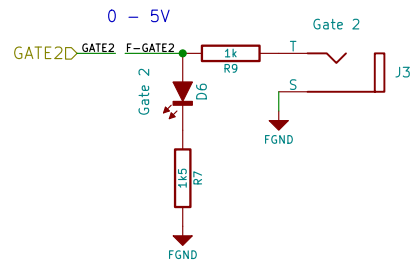
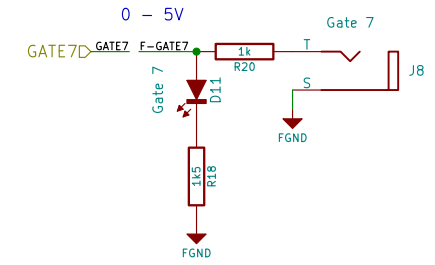
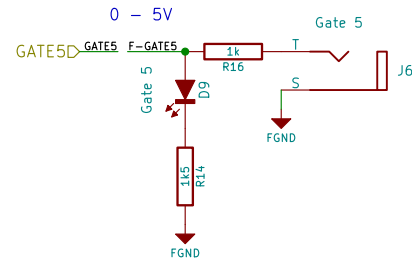
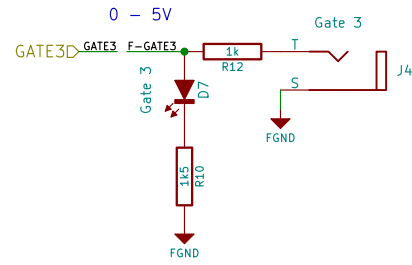
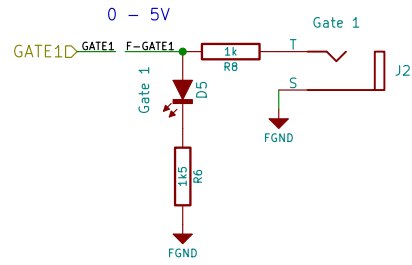

www.davidhailant.com

David Hailant

Sheet: /Gate Outputs/

File: gate_out.sch

Title: UC Clock Divider

Size: A4

Date: 2021-12-07

Rev: 1.0

KiCad E.D.A. kicad 6.0.1-79c1e3a40b-116-ubuntu20.04.1

Id: 5/5